

**Model : UT-8801**  
**USB/RS-232**  
**Interface Converter**

**User Manual**

# **【CONTENTS】**

I. Summary.....	3
II. Functions.....	3
III. Hardware installment and application.....	3
IV. Performance parameters.....	4
V. Connector and signal.....	4
VI. Communication Connection Chart.....	5
VII. Problems and troubleshooting.....	6
VIII. Product image.....	6
IX. Driver installation.....	7-14

## **、 Summary**

With rapid development of computer industry, USB is taking the place of various kinds of traditional low speed peripheral interfaces. However, RS-232 interface designs are still used in many of the important facilities under current industrial environment , therefore, converter is used by many users to implement the data transmission from USB of a computer to RS-232 equipments.

UT-8801 is a universal USB/RS-232 interface converter. No external power supply needed. Compatible with USB and RS-232 standards, UT-8801 is capable to perform the conversion from single-ended USB signal into UART signal of RS-232. DB9 male connectors are used for connection from RS-232 interface. The unique I/O circuit of the internal zero delay auto transceiver contained in the converter controls the data stream direction automatically. The converter is plug-and-play. All these features ensure a universal application on all the existing communication software and hardware interfaces.

The data communication rate can be as high as 300-921.6Kbps by the point-to-point communication by UT-8801 interface. Power indicator light and data traffic indicator light are also available with the converter for malfunction indication. Conversion from USB to RS-232 is supported.

## **. Functions**

UT-8801 interface converter supports the following communication mode:

1. Point-to-point communication mode.

## **. Hardware installment and application**

Read the user manual carefully before installing the UT-8801 interface converter. Put the signal cable of the equipment into the USB socket.USB/DB9 male connectors are adopted for input/output interface connection for this product.

## **. Performance parameters**

1. Standards: conforming to USBV1.0, 1.1 and 2.0 and EIA RS-232.
2. USB signals: VCC, DATA+, DATA-, GND and FG.

3. RS-232 signals: DCD RXD TXD DTR GND DSR RTS CTS RI
4. Working mode: asynchronous point-to-point.
5. Direction control: adoption of automatic data stream control for automatic recognition and control of data transmission direction.
6. Baud rate: 300-921.6Kbps, automatic detection of the transmission rate of the serial interface signal.
7. Transmission distance: 5 meters for RS-232 and less than 5 meters for USB.
8. Interface protection: +-15KV electrostatic protection.
9. Interface forms: B interface female connector and DB9 male connector for USB.
10. Signal indication: 9 indicator lights for Power (PWR), Send (TXD) and Receive (RXD).
11. Transmission media: twisted-pair cable or shielded cable.
12. Dimensions: 1530mm × 33mm × 16mm.
13. Working environment: -25 to 70 , relative humidity 5% to 95%.
14. Windows95/98/2000/XP/Vista and IMAG are supported.
15. Both BUS and external power supply are supported.

. Connector and signal

1. DB9 PIN: RS-232 output signals and PIN assignment

DB9 Female (PIN)	RS-232C interface signal
1	Protection grounding DCD
2	Receiving data SIN (RXD)
3	Sending data SOUT (TXD)
4	Data terminal preparation DTR
5	Signal grounding GND
6	Data equipments preparation DSR
7	Request sending RTS
8	Clear sending CTS
9	Ring indication RI

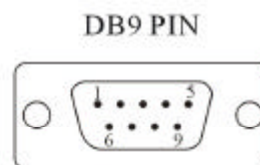

2. USB-B female: USB output signals and PIN assignment

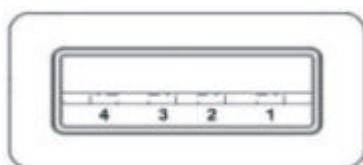

- 1、 VCC
- 2、 DATA-(DM)
- 3、 DATA+(DP)
- 4、 GND

VI. Communication Connection Chart

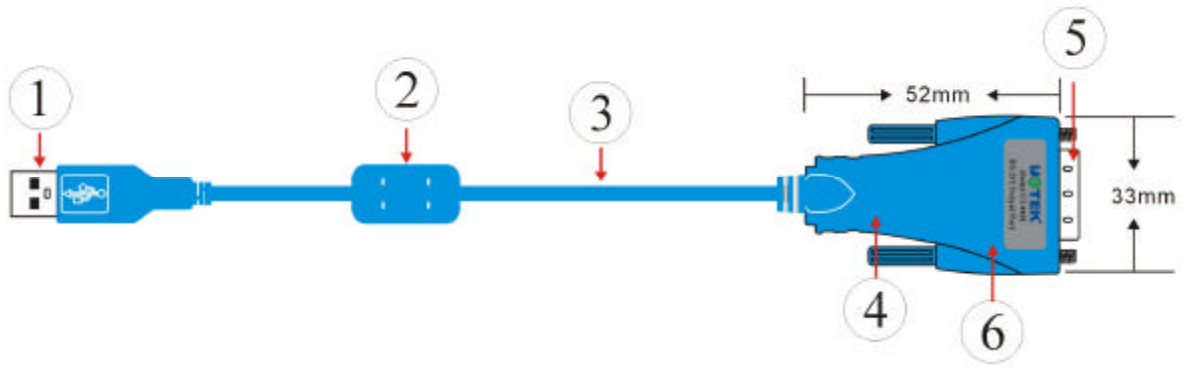

- 1、 Standard USB A type male connector
- 2、 Transparent and shielded standard 2.0 communication line
- 3、 Fine shell(blue)
- 4、 Standard DB9 male connector
- 5、 MCU adopts the product of the British FTDI company

### USB To RS-232 Communication

- 1、 DCD 2、 RXD 3、 TXD 4、 DTR 5、 GND 6、 DSR 7、 RTS 8、 CTS 9、 RI

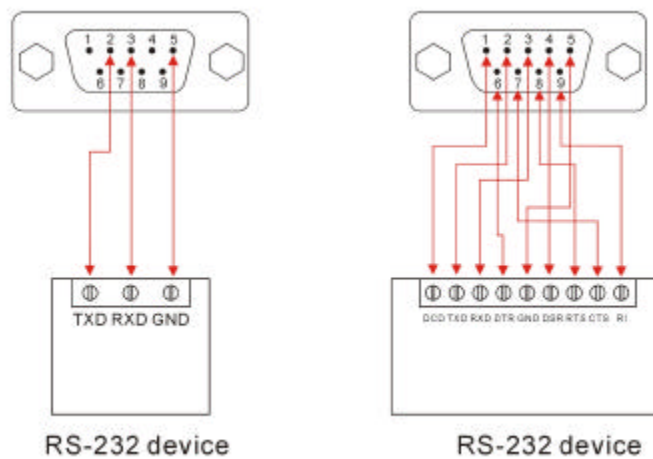

### VII. Problems and troubleshooting

1. Data communication failure
  - A. Check to make sure USB cable is OK.
  - B. Make sure RS-232 output interface connection is correct.
  - C. Make sure power supply is OK.
  - D. Make sure the wire terminal connection is OK.

E. Make sure the indicator lights flash when receiving.

F. Make sure the indicator lights flash when sending.

## 2. Data missing or incorrect

A. Check to see whether the data rate and format at both ends of the communication equipment are consistent.

## . Product image



## IX. Driver installation

Once a UT-8801 converter is connected with the USB port, the following window will pop up. Select Install from a list or specific location (Advanced), then click Next to continue.

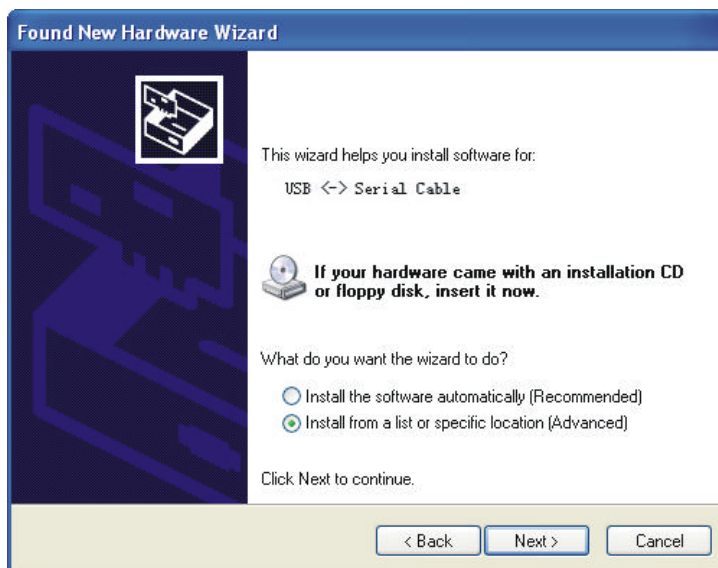

Then a window pops up to choose search and installation options as the following, please select Don't search. I will choose the driver to install. and then click Next to continue.

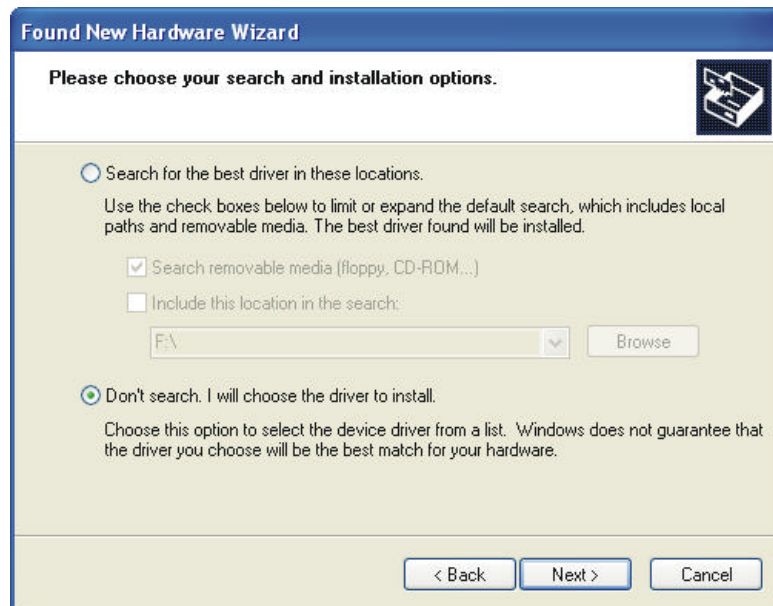

Then a window pops up for Hardware Type listing, pull the scroll bar to select Universal Serial Bus Controllers and click Next to continue.

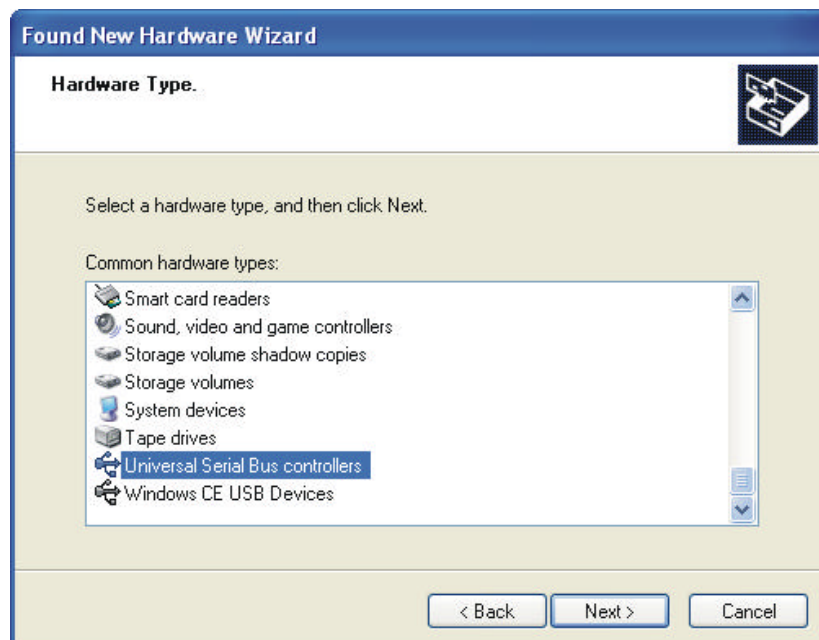

In the following Select the device driver you want to install for this hardware, click Have Disk to continue.

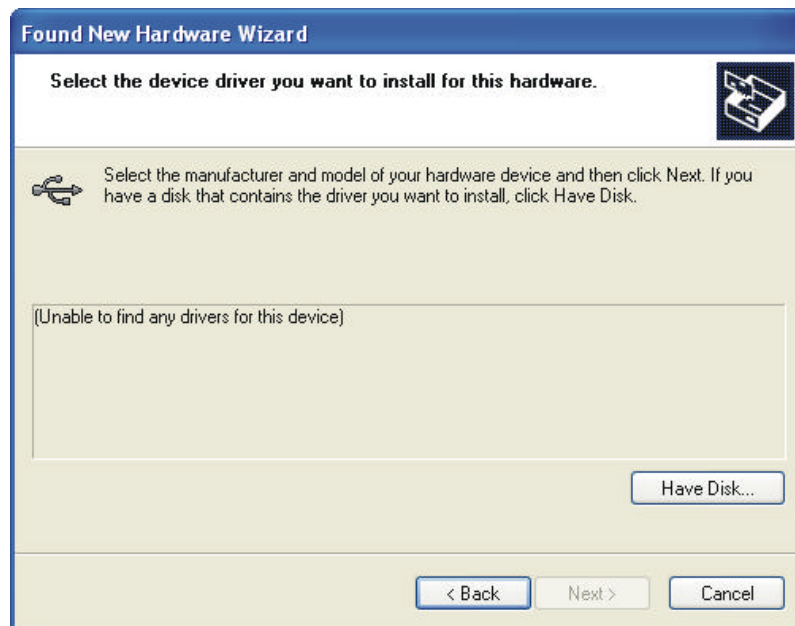

In the Install From Disk window, click Browse to select the path of the device driver.

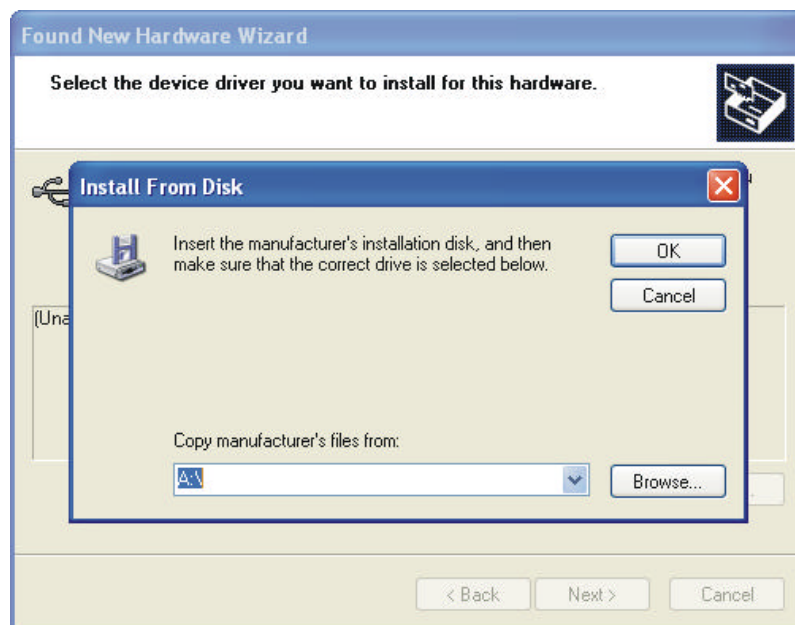



In the Locate File window, select CD path, then choose the directory Driver and click the button Open or double click to open.

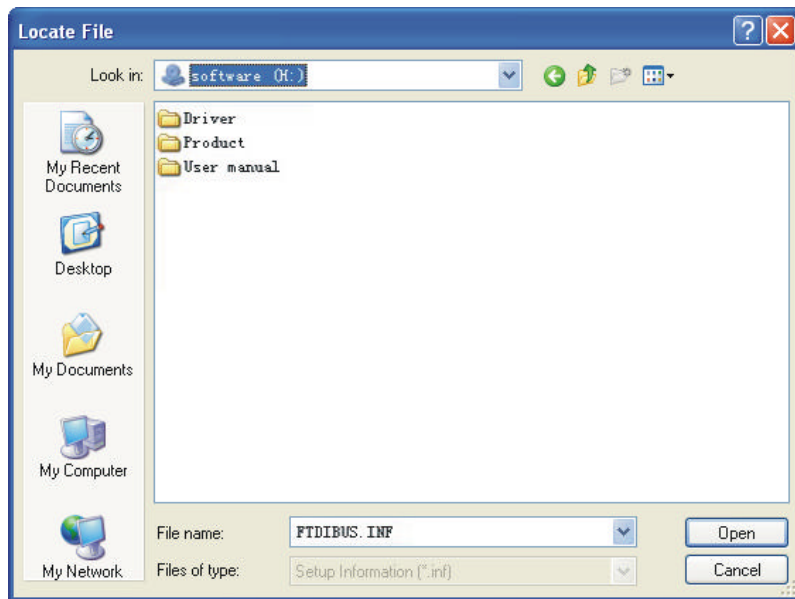

Select the driver model as the following, then click the directory UT-8801 to open, select PC Driver directory.

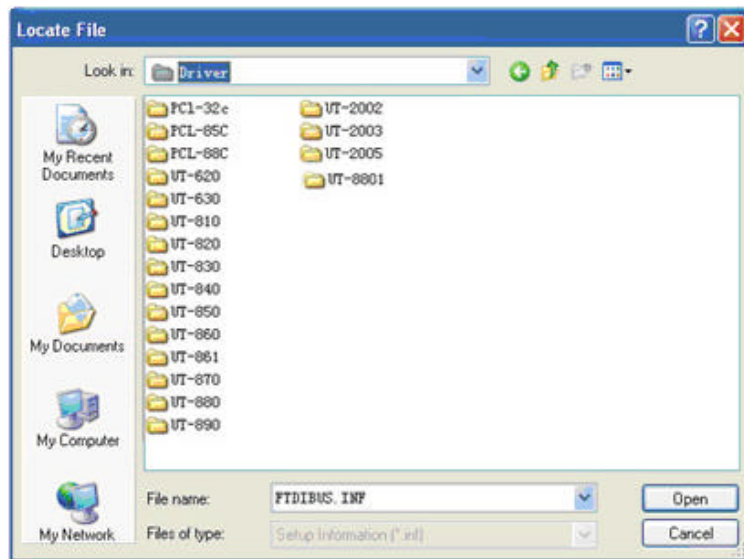

Select the applicable operation system, e.g. select and double click to open WINXP.2003.2000 for Windows XP.

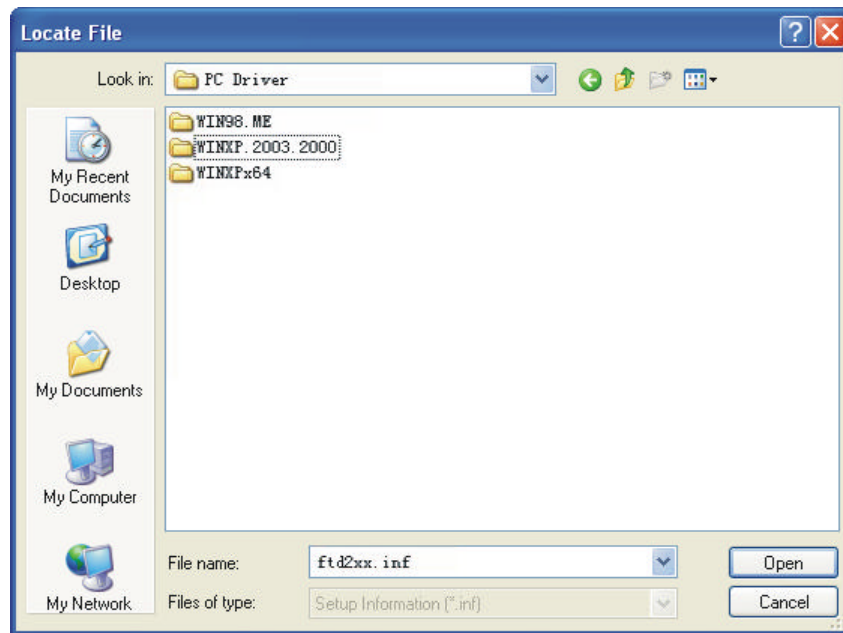

Select the file FTDIBUS.INF, then click Open.

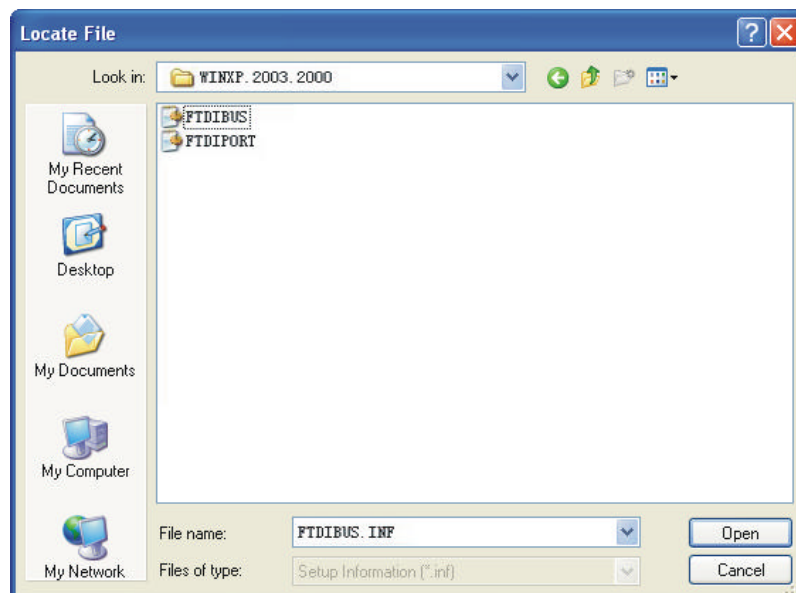

In the following Install From Disk window, just click OK.

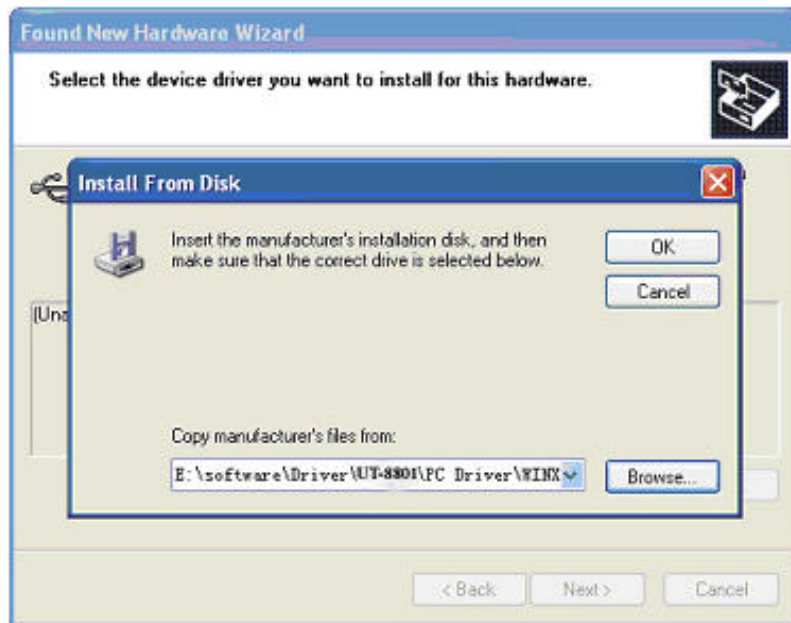

Installation information has been located by the system as the following, just click Next to continue.

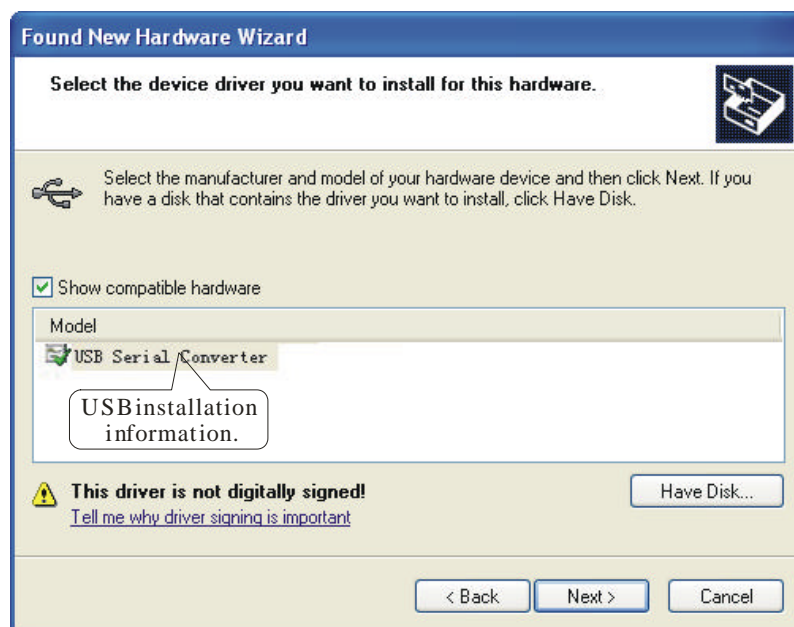

The following shows that the USB Serial Converter installation is finished, then the system wizard will detect USB Serial Port automatically.

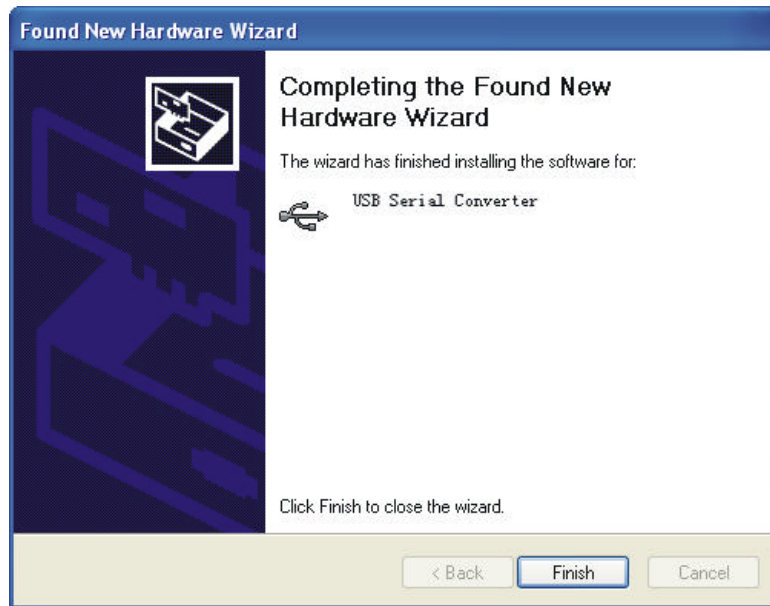

The following is the Found New Hardware Wizard for USB Serial Port, click Next as for USB Serial Converter, the same steps are omitted here.

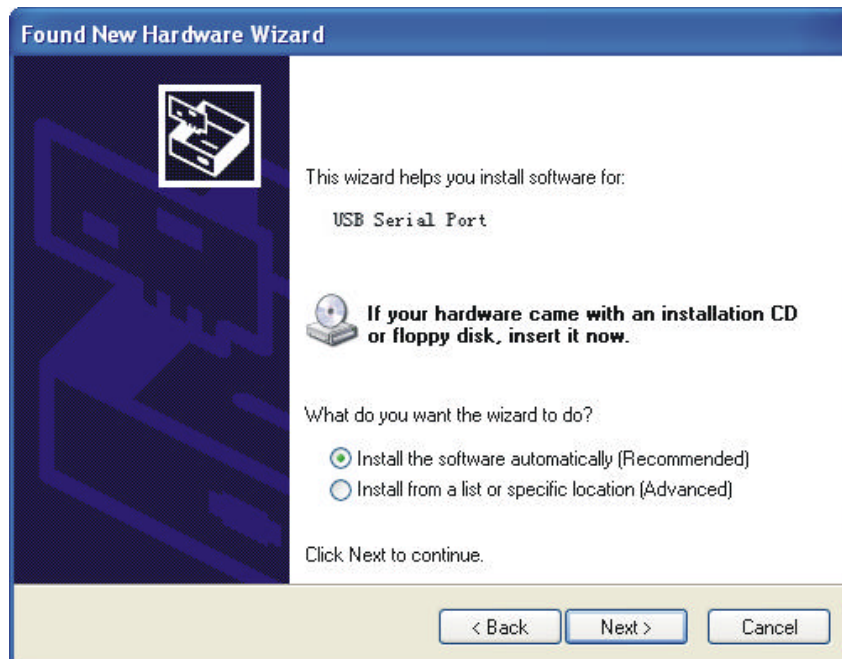

Installation information has been located by the system as the following, just click Next to continue.

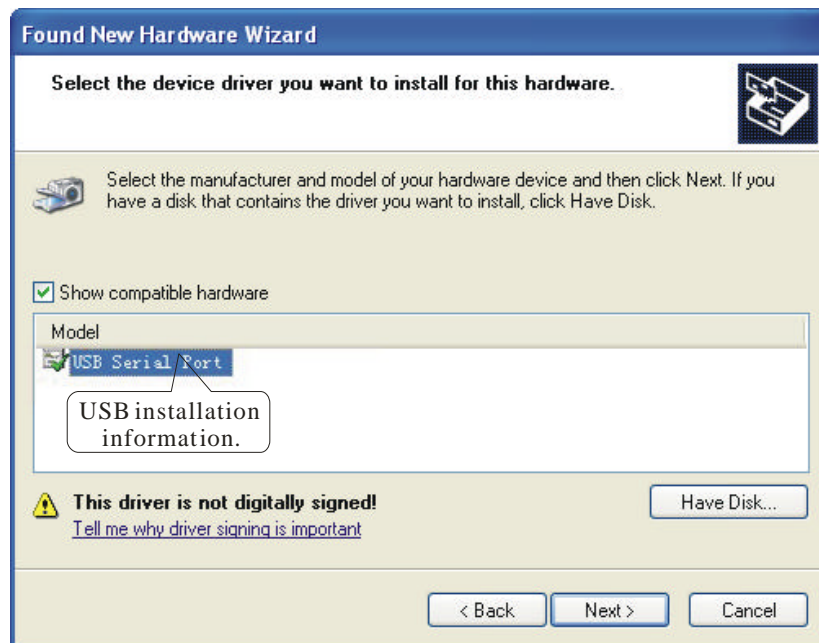

The following shows the USB Serial Port installation is finished. Up to now, all the drivers for UT-8801 are installed.



After installation, you can open Device Manager to check if there are COM ports available now, if no USB drivers have been installed previously. System default COM ports are COM 3, as illustrated below. Now, all the installation is finished.

